

Exercice n° 1: (5 points)

$$F_1 = \bar{a}(b + \bar{c}) \cdot d + f\bar{b}$$

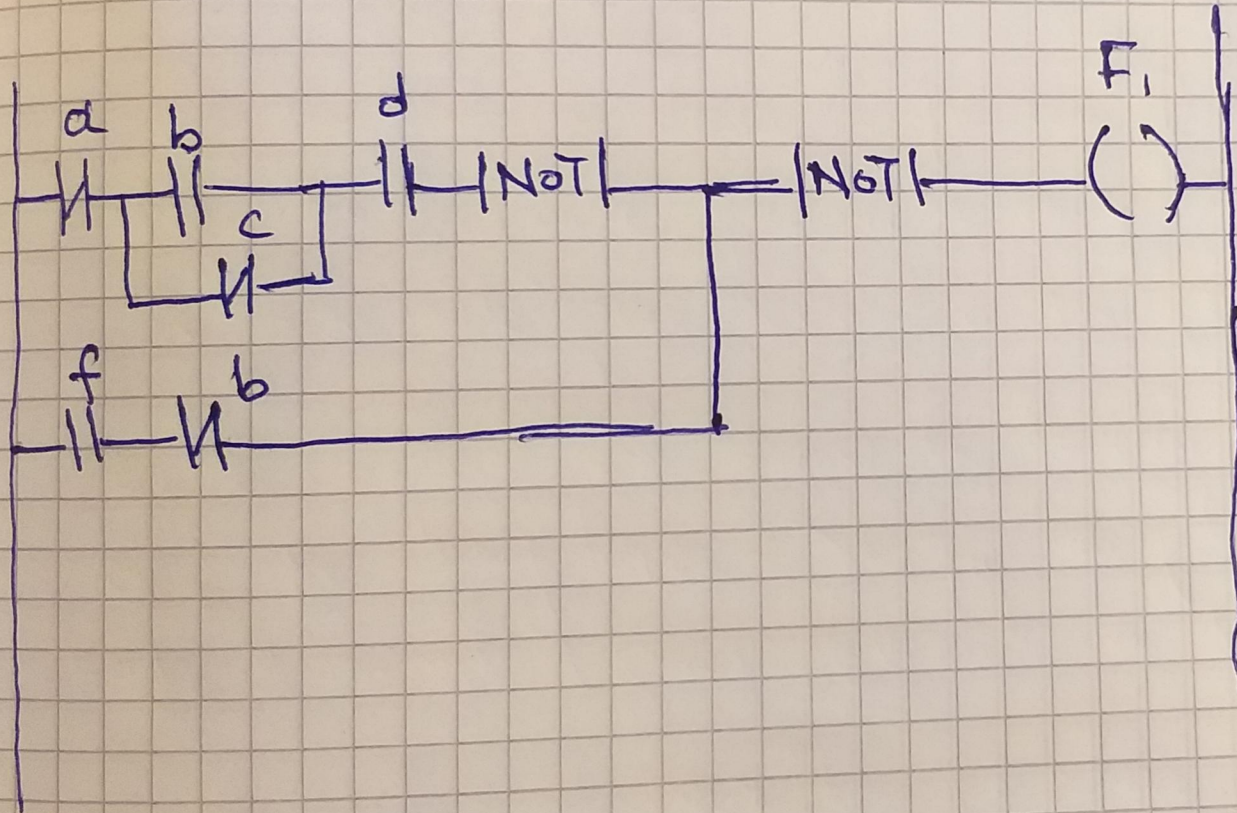

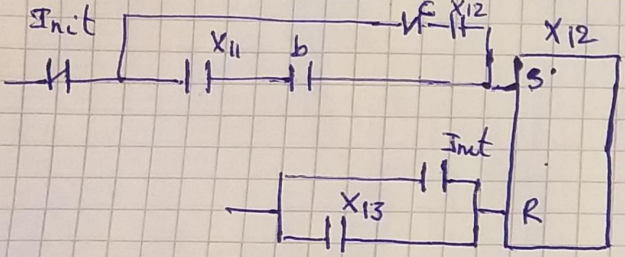
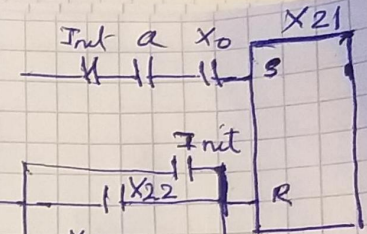
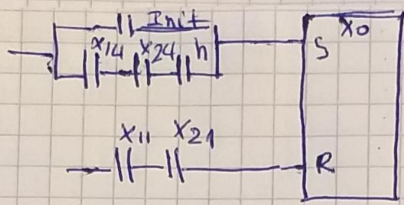
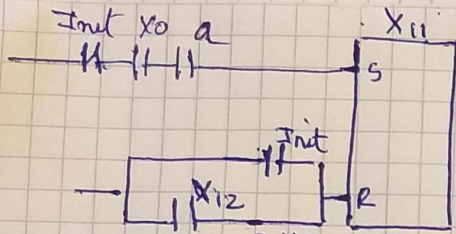

$$S_1 = X_{11} \quad V_1 = X_{21}$$

$$S_2 = X_{12} \quad V_2 = X_{22}$$

$$S_3 = X_{13} \quad V_3 = X_{23}$$

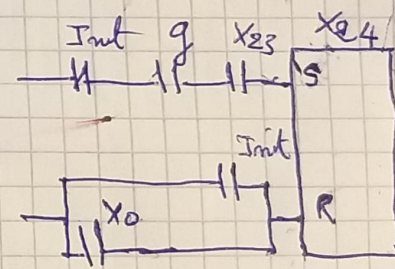
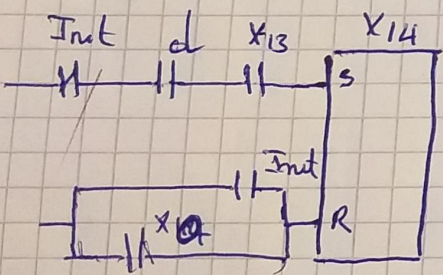
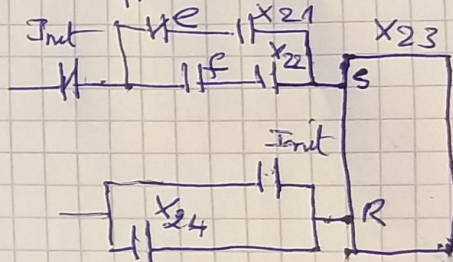
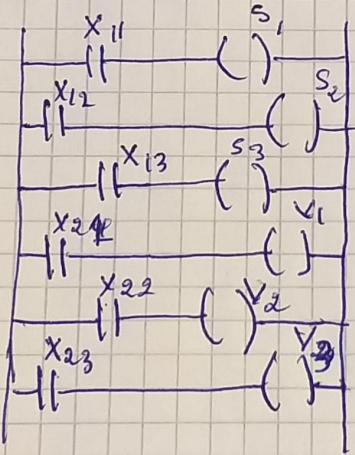
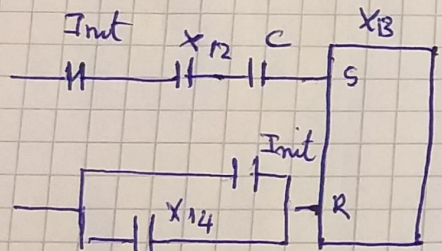
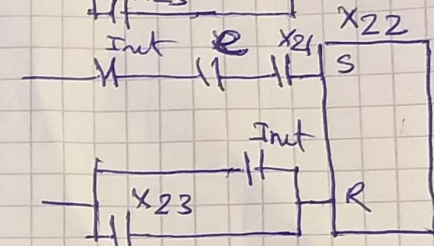

Exercice N°3

